



**Cybex Eagle® Abdominal  
Owner's Manual  
Strength Systems  
Part Number 11090-999-4 A**





**Cybex Eagle® Abdominal  
Owner's Manual  
Strength Systems  
Part Number 11090-999-4 A**

Cybex® and the Cybex logo are registered trademarks of Cybex International, Inc.  
Eagle® and its mark are registered trademarks of Cybex International, Inc.

**DISCLAIMER:** Cybex International, Inc., makes no representations or warranties regarding the contents of this manual. We reserve the right to revise this document at any time or to make changes to the product described within it without notice or obligation to notify any person of such revisions or changes.

© Copyright 2010, Cybex International, Inc. All rights reserved.

Printed in the United States of America.  
10 Trotter Drive Medway, MA 02053 • 508-533-4300 • FAX 508-533-5183  
www.cybexinternational.com • techhelp@cybexintl.com • 11090-999-4 A



# Table of Contents

<b>1 Safety</b>	
Safety . . . . .	1-1
Safety Guidelines and Practices . . . . .	1-2
Warning/Caution Decals . . . . .	1-3
Regular Maintenance Activities . . . . .	1-5
Using Proper Form . . . . .	1-5
<b>2 Exercises</b>	
Intended Use . . . . .	2-1
Instructions. . . . .	2-1
<b>3 Customer Service</b>	
Contacting Service. . . . .	3-1
Ordering parts . . . . .	3-1
Return Material Authorization (RMA). . . . .	3-1
Damaged Parts . . . . .	3-2
<b>4 Assembly</b>	
Assembly . . . . .	4-1
<b>5 Maintenance</b>	
Daily Procedures . . . . .	5-1
Weekly Procedures . . . . .	5-4
Yearly Procedures . . . . .	5-6
Environment. . . . .	5-7
Storage . . . . .	5-7



# 1 - Safety

## Safety

Read the Owner's Manual carefully before assembling, servicing or using the equipment.

It is the responsibility of the facility owner and/or owner of the equipment to instruct users on proper operation of the equipment and review all labels.

 **WARNING: Serious injury could occur if these safety precautions are not observed:**

### User Safety Precautions

- Obtain a medical exam prior to beginning an exercise program.
- Read and understand warning labels and user manual prior to exercising. Obtain instruction prior to use. 
- Keep body and clothing free from and clear of all moving parts.
- Inspect machine prior to use. **DO NOT** use if it appears damaged or inoperable.
- **DO NOT** attempt to fix a broken or jammed machine. Notify floor staff.
- Use the machine only for the intended use. **DO NOT** modify the machine.
- Be sure that the weight pin is completely inserted. Use only the pin provided by the manufacturer. If unsure seek assistance.
- Never pin the weights in an elevated position. **DO NOT** use the machine if found in this condition. See assistance from floor staff.
- Children must not be allowed near these machines. Teenagers must be supervised.
- **DO NOT** use if guards are missing or damaged.
- **DO NOT** use dumbbells or other incremental weights, except those provided by the manufacturer.
- Inspect all cables and belts and connections prior to use. **DO NOT** use if any components are worn, frayed or damaged.
- **DO NOT** remove any labeling from equipment. Replace any damaged labels.
- Stop exercising if you feel faint, dizzy or experience pain at any time while exercising and consult your physician.

### Facility Safety Precautions

- Read the Owner's Manual carefully before assembling, servicing or using the equipment.
- Securely anchor each machine to the floor using the anchor holes provided in each machine.

**NOTE:** *Cybox is not responsible for the actual anchoring of equipment. Consult with a professional contractor.*

**NOTE:** *Use fasteners having a minimum of 500 lbs. tensile capacity (3/8" grade 2 bolts or better).*

**NOTE:** *If legs/frame does not contact surface, DO NOT pull down with anchors. Shim any leg or frame not in contact with surface using flat washers.*

## ***Cybex Eagle 11090 Abdominal Owner's Manual***

- Make sure that each machine is set up and operated on a solid level surface. **Do not install equipment on an uneven surface.**
- Make sure that all users are properly trained on how to use the equipment.
- Make sure there is enough room for safe access and operation of the equipment.
- Perform regular maintenance checks on the equipment. Also pay close attention to all areas most susceptible to wear, including (but not limited to) cables, pulleys, belts and grips.
- Immediately replace worn or damaged components. If unable to immediately replace worn or damaged components then remove from service until the repair is made.
- Use only Cybex supplied components to maintain/repair the equipment.
- Keep a repair log of all maintenance activities.
- Inspect all cables and belts and connections prior to use. **DO NOT** use if any components are worn, frayed or damaged.

**NOTE:** *It is the sole responsibility of the user/owner or facility operator to ensure that regular maintenance is performed.*

### ***Safety Guidelines And Practices***

Cybex recommends that all fitness equipment be used in a supervised area. It is recommended that the equipment be located in an access controlled area. Control is the responsibility of the owner. The extent of control is at the discretion of the owner.

It is the responsibility of the purchaser/user of Cybex products to read and understand the owner's manual, and warning labels; as well as instruct all individuals, whether end users or supervising personnel, on proper usage of the equipment.

#### **PROPER USAGE:**

Use machine only as described in the manual. Failing to follow proper instructions may result in injury.

**Do Not Lean Against or Pull** On the framework, weight stack, or any component, whether machine is at rest or in use. Inappropriate or improper use may result in injury to users or third parties (bystanders).

Do not use machine if it is not located on a solid level surface or is improperly installed.

Provide an adequate safety perimeter between the machine, walls and other equipment to ensure that the facility has the proper clearance for usage and training.

#### **SECURING EQUIPMENT:**

The machine has holes in the feet, which allow for ease in anchoring to the floor. Cybex strongly recommends that, to eliminate rocking, tipping or falling over due to incorrect usage and misuse, equipment be secured to a solid, level surface.

1. The solid, level surface should not deviate more than 1/8" over a 10' distance or as defined and required by local building and architectural codes.
2. Anchoring of equipment must be completed by a qualified licensed contractor.



3. Anchoring holes are provided on the feet of the frame. All anchoring locations must be used when anchoring the equipment to the floor.
4. Due to the wide variation of flooring on which machines may be anchored or installed, verify anchoring method and anchoring fasteners with a qualified and licensed contractor.
5. A minimum pull out force of 220 lbs/100 kgs is required for each anchor position..
6. Do not use machine until it is properly anchored.

**MAINTENANCE:**

Preventative maintenance allows proper equipment operation and reduces the risk of injury. Perform the maintenance requirements as specified in the manual.

**STANDARD COMPLIANCE:**

Cybex products meet or exceed applicable ASTM and EN Standards.



***Warning/Caution Decals***

Warning decals indicate a potentially hazardous situation, which, if not avoided, could result in death or serious injury.

Caution decals indicate a potentially hazardous situation, which, if not avoided, could result in minor or moderate injury.

The warning and caution decals are shown on the following page. The diagrams following the decals show where each decal is located.

**⚠ WARNING**

**SERIOUS INJURY  
COULD OCCUR IF  
THESE PRECAUTIONS  
ARE NOT OBSERVED**

1. Obtain a medical exam prior to beginning an exercise program.
2. Read and understand warning labels and user manual prior to exercising. Obtain instruction prior to use. 
3. Keep body and clothing free from and clear of all moving parts.
4. Inspect machine prior to use. DO NOT use if it appears damaged or inoperable.
5. DO NOT attempt to fix a broken or jammed machine. Notify floor staff.
6. Use the machine only for the intended use. DO NOT modify the machine.
7. Be sure that the weight pin is completely inserted. Use only the pin provided by the manufacturer. If unsure seek assistance.
8. Never pin the weights in an elevated position. DO NOT use the machine if found in this condition. Seek assistance from floor staff.
9. Children must not be allowed near this machine. Teenagers must be supervised.
10. DO NOT use if guards are missing or damaged.
11. DO NOT use dumbbells or other incremental weights, except those provided by the manufacturer.
12. Inspect all cables and belts and connections prior to use. DO NOT use if any components are worn, frayed, or damaged.
13. DO NOT REMOVE THIS LABEL. REPLACE IF DAMAGED.

4605-381-4 B

A

B

**⚠ CAUTION**

**Personal injury may occur.  
Keep away from moving  
parts to avoid injury.**

4000Y316-4 A

C

**⚠ CAUTION**



**Keep away from moving  
parts. Failure to do so could  
result in personal injury.**

8500-026-4 A

Abdominal - 11090

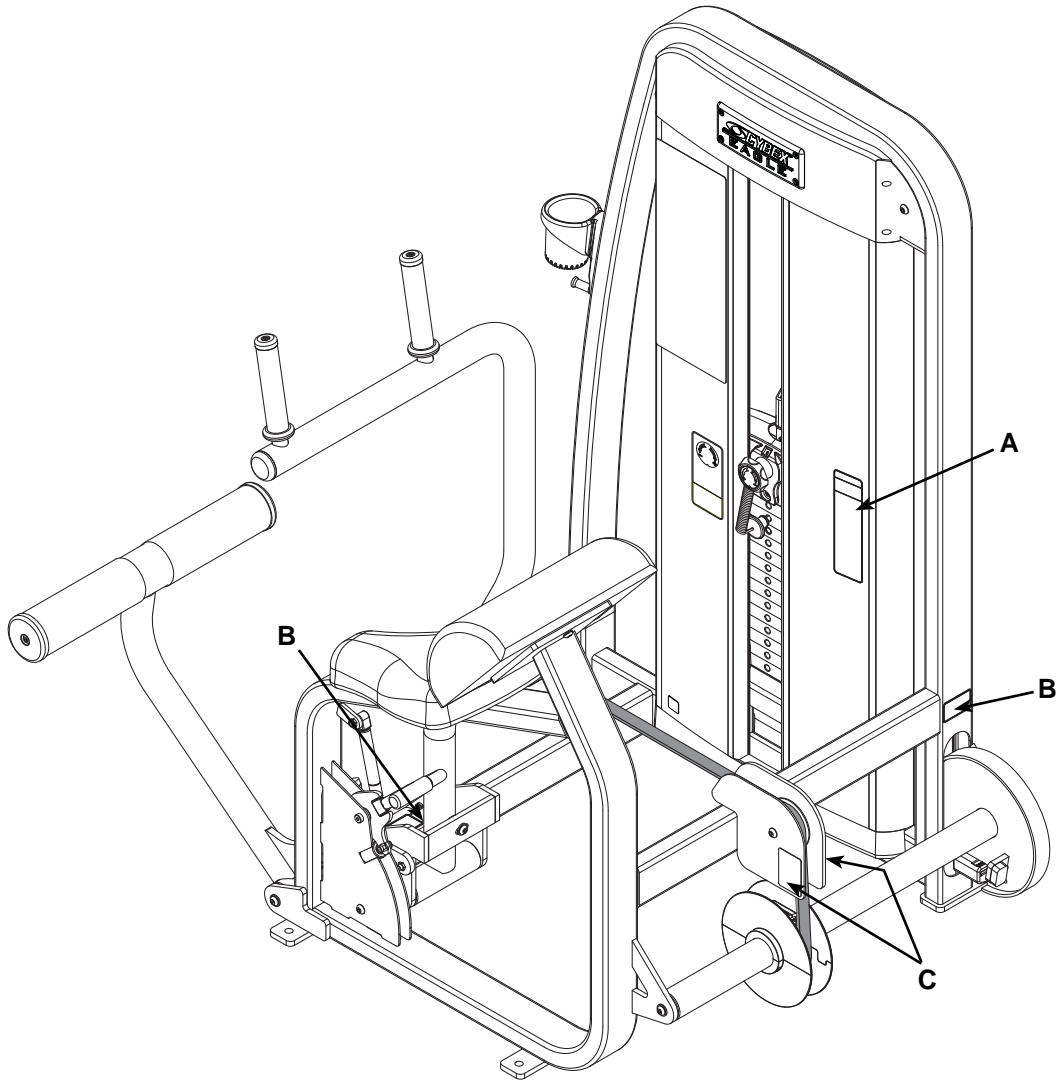

DESCRIPTION	PART NO.
A. Warning Decal.....	4605-381-4
B. Caution Decal.....	4000Y316-4
C. Caution Decal.....	8500-026-4

## ***Regular Maintenance Activities***

Preventative maintenance activities must be performed to maintain normal operation of your equipment. Keeping a log sheet of all maintenance actions will assist you in staying current with all preventative maintenance activities. The preventative maintenance actions are described in detail in Chapter 5.

Briefly, they include:

### **Daily**

1. Clean upholstery.

### **Weekly**

1. Inspect all nuts and bolts for looseness. Tighten as required.
2. Inspect all cables and belts for damage or wear (see Chapter 5). **If a cable or belt is worn or damaged, immediately discontinue use until cable or belt has been replaced.**
3. Check for worn handles, worn snap links, and worn warning labeling. Replace all worn parts immediately.
4. Inspect for loose or worn grips. Replace all loose or worn grips immediately.
5. Inspect weight stacks for proper alignment and operation. Correct all improper alignment and operation issues immediately.
6. Lubricate guide rods using automotive engine oil only.

### **Yearly**

1. Replace all cables and belts at least annually.

## ***Using Proper Form***

Before working out, read and understand the exercises located on the placard and in Chapter 2.

## 2 - Exercise

### Intended Use

The intended use of this equipment is to aid or improve general physical fitness and exercise. For Commercial use.

### Instructions

Read and understand all instructions and warnings prior to using this machine. See Chapter 1, Safety in the Eagle Owner's Manual or consult with floor staff.

### MUSCLES USED

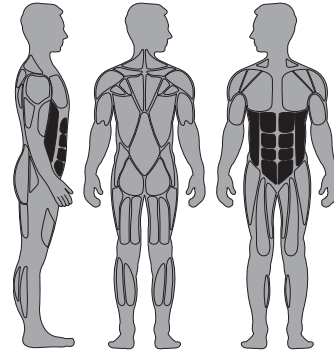

Rectus Abdominis,  
Internal and External Oblique

START



FINISH



**NOTE:** Motion Developed: Trunk Flexion

**NOTE:** All adjustment points on the machine have yellow handles or knobs.

**NOTE:** See next page for "Set Up" and "Movement".

**NOTE:** Do not turn knob when weight stack is elevated

## ***Cybox Eagle 11090 Abdominal Owner's Manual***

### **Set Up**

1. Adjust foot bar for a bend at the knees.
2. Extend legs to keep back firmly against pad while keeping a slight bend at the knee.
3. Grasp handles, lean back while extending arms.

### **Movement**

1. Push the handles by bending forward from the trunk while keeping arms fully extended.

## 3 - Customer Service

### Contacting Service

Hours of phone service are Monday through Friday from 8:30 a.m. to 6:00 p.m Eastern Standard Time.

For Cybox customers living in the USA, contact Cybox Customer Service at **888-462-9239**.

For Cybox customers living outside the USA, contact Cybox Customer Service at **508-533-4300** or fax **508-533-5183**.

Find information on the web at [www.cyboxintl.com](http://www.cyboxintl.com) or e-mail at [techhelp@cyboxintl.com](mailto:techhelp@cyboxintl.com).

### Ordering Parts

Fax orders to **508-533-5183**. To speak with a customer service representative, call **888-462-9239** (for customers living within the USA) or **508-533-4300** (for customers outside the USA).

You may also contact us through e-mail at [techhelp@cyboxintl.com](mailto:techhelp@cyboxintl.com).

Having the following information ready when calling, will assist our Cybox representatives in serving you.

- **Unit Serial Number**
- **Product Name**

The unit serial number and product name can be found on the serial number decal.

- **Part Description**
- **Part Number**

Part descriptions and part numbers are located on the web at [www.cyboxintl.com](http://www.cyboxintl.com).

- **Shipping Address**
- **Contact Name**

In addition to your shipping address and contact name, your account number is helpful but not required.

### Return Material Authorization (RMA)

The Return Material Authorization (RMA) system outlines the procedures to follow when returning material for placement, repair or credit. The system assures that returned materials are properly handled and analyzed. Follow the following procedures carefully.

Contact your authorized Cybox dealer on all warranty-related matters. Your local Cybox dealer will request a RMA from Cybox, if applicable. Under no circumstances will defective parts or equipment be accepted by Cybox without proper RMA and an Automated Return Service (ARS) label.



**NOTE:** All inspections and repairs must be performed by trained service personnel only.

**Cybox will void warranty if non-Cybox replacement parts are used.**

## **Cybex Eagle 11090 Abdominal Owner's Manual**

1. Call the Customer Service Hot Line listed above for the return of any item that is defective.
2. Provide the technician with a detailed description of the problem you are having or the defect in the item you wish to return.
3. Provide the model and serial number of your Cybex equipment.
4. At Cybex's discretion, the technician may request that you return the problem part(s) to Cybex for evaluation and repair or replacement. The technician will assign you a RMA number and will send you an ARS label. The ARS label and the RMA numbers must be clearly displayed on the outside of the package that contains the item(s) to be returned. Include the description of the problem, the serial number of the equipment and the name and address of the owner in the package along with the part(s).
5. Forward the package through UPS to Cybex.

Attn: Customer Service Department  
Cybex International, Inc.  
1975 24th Ave SW  
Owatonna, MN 55060

**NOTE:** *Merchandise returned without an RMA number on the outside of the package or shipments sent COD will not be accepted by the Cybex receiving department.*

### **Damaged Parts**

Materials damaged in shipment should not be returned for credit. Shipping damages are the responsibility of the carrier (UPS, Federal Express, trucking companies, etc.)

**Apparent Damage** - Upon receipt of your shipment, check all items carefully. Any damage seen with a visual check must be noted on the freight bill and signed by the carrier's agent. Failure to do so will result in the carrier's refusal to honor your damage claim. The carrier will provide you with the required forms for filing such claims.

**Concealed Damage** - Damage not seen with a visual check upon receipt of a shipment but notices later must be reported to the carrier as soon as possible. Upon discovery of the damage, a written or phone request to the carrier asking them to perform an inspection of the materials must be made within ten days of the delivery date. Keep all shipping containers and packing materials as they will be needed in the inspection process. The carrier will provide you with an inspection report and the necessary forms for filing a concealed damage claim. Concealed damage claim is the carrier's responsibility. Cybex, if applicable. Under no circumstances will defective parts or equipment be accepted by Cybex without proper RMA and an Automated Return Service (ARS) label.



# 4 - Assembly

## TOOLS REQUIRED

- 7/32" Allen wrench
- 3/4" Allen wrench
- 9/16" Wrench
- External snap ring pliers
- Phillips screwdriver
- Medium weight automotive engine oil
- Torque Wrench

**NOTE:** Two people will be required for this procedure.

**NOTE:** It is the responsibility of the facility owner/ owner of the equipment to ensure that there is appropriate clearance around each machine to allow for safe use and passage.

ITEM	QTY	PART NO.	DESCRIPTION
1	4	11090-392	FOOT PAD
2	1	12000-560	DECAL, WEIGHT PLATE (30 - 290)
3	14	4000C101	WEIGHT STACK PLATE

1. Read and understand all instructions thoroughly before starting any of the procedures listed on this instruction sheet.
2. Verify you have received the appropriate configuration.
  - A. Verify that you received the correct color machine that you ordered.
  - B. Verify you received weight plates and weight plate decals.
  - C. Verify you received the Cybex Eagle Abdominal Owner's Manual.
  - D. Verify you received the warranty sheet.
3. Move to desired location.
  - A. Note the dimensions of the machine:
    - Idle - 59 L x 44 W x 58 H inches  
149.86 L x 111.76 W x 147.32 H cm
    - In use - 59 L x 44 W x 58 H inches  
149.86 L x 111.76 W x 147.32 H cm
    - Machine Weight with weight stack - 524 lbs. (237.68 kg)
  - B. Determine if you can move your machine through the required doorway(s).
  - C. If the machine fits through the doorway(s), move machine to desired location and skip to step 5.
  - D. If weight stacks need to be installed proceed to step 6.
  - E. If the machine does not fit through the doorway(s) then see step 4.

## 4. Doorway Instructions.

**NOTE:** If your machine fits through the doorway then skip step 4.  
If your machine does not fit through the doorway, then perform step 4.

- A. Carefully remove each (standard) cone-shaped shipping support using a 3/4" socket or wrench.
- B. Make a note of the current belt routings and connections. This will assist you in reinstalling them properly.
- C. Cut shipping tie securing top weight.

- D. Rotate cam and disconnect weight stack belt from cam (by loosening the two set screws on the belt clamp with a 7/32" Allen wrench). See Figure 1.
- E. Locate the belt attached to the pivot arm. Remove the shoulder bolt and hex nut securing belt to the pivot arm. Figure 2.
- F. Remove pulley then remove other end of belt from cam. See Figure 3.
- G. Remove one of the two BHSCS (Button Head Socket Cap Screws) securing the pivot shaft. See Figure 3.
- H. Carefully remove pivot shaft and pulley shaft. See Figure 3. **NOTE:** Be extremely careful when removing shaft so you don't ruin the threads on the shaft.
- I. With an assistant, carefully remove the six BHSCS securing the two halves of the frame. See Figure 4.
- J. Carefully move each half through the door-way to the desired location.
- K. With an assistant, carefully attach each half together using the six BHSCS removed in step 4I. See Figure 4.
- L. Carefully attach pulley shaft using the pivot shaft and BHSCS removed in steps 4G and 4H. See Figure 3.
- M. Reconnect belt to cam and reinstall pulley (removed in step 4F).
- N. Connect other end of belt to the arm using the BHSCS and nylon locknut from step 4E. See Figure 2.
- O. Connect the weight stack belt to the belt clamp of cam (removed in step 4D). See Figure 1.
- P. Continue on with Step 5C.

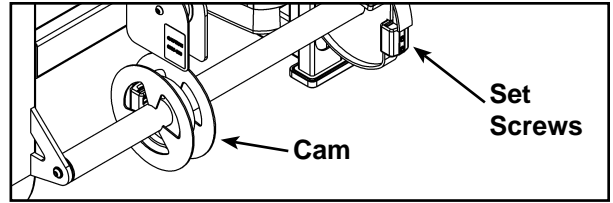

Figure 1

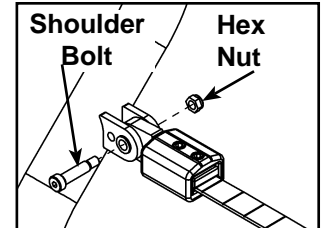

Figure 2

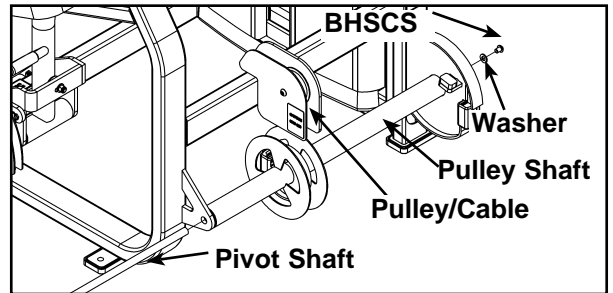

Figure 3

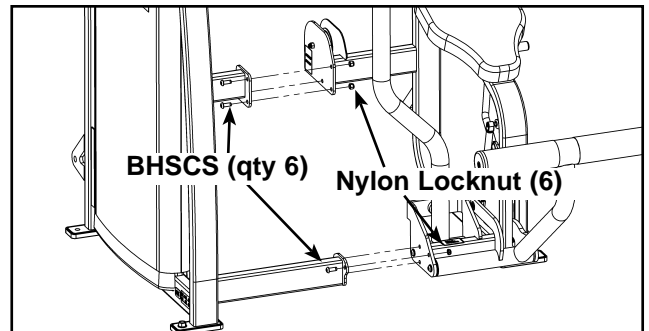

Figure 4

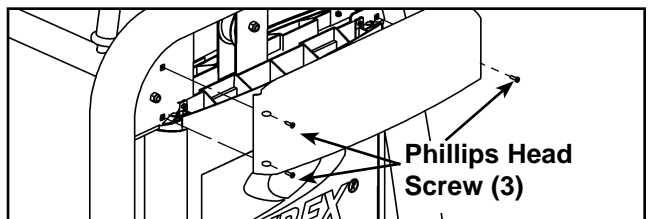

Figure 5

**5. Remove shipping feet and remove the back shrouds.**

- A. Carefully remove each (standard) cone-shaped shipping support) using a 3/4" socket or wrench).
- B. Cut shipping tie securing top weight.
- C. Carefully place rubber feet (supplied with machine) on each foot of the frame.
- D. Lift top weight and turn the Increment Weight Adjusting Knob to select all 15 lbs. (three increment weights each side).
- E. Remove the three Phillips head screws securing the top (back) shroud and carefully remove the shroud. See Figure 5.

- F. Loosen bottom two screws shown in Figure 6. **NOTE:** Do not remove the bottom two screws.
- G. Remove the top two screws securing the back shroud. See Figure 7.
- H. Carefully slide rear shroud assembly upward and remove.

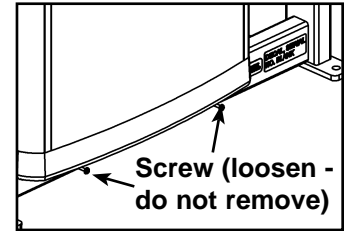

Figure 6

**6. Install the weight stack.**

- A. Note how the increment weights are installed.
- B. With an assistant holding the increment weights, move the adjusting knob to 0 lbs. and remove all six increment weights (three each side).
- C. Using an external snap ring pliers, remove the upper snap ring from one of the guide rods and carefully lower the guide rod. See Figure 8.
- D. Remove lower snap ring and wave washer from the guide rod. Repeat steps 6C and 6D to remove both snap rings from other guide rod.

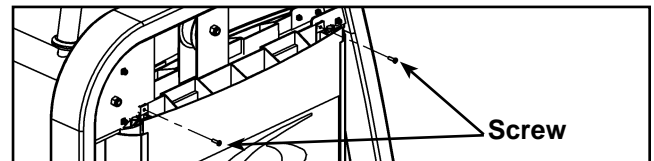

Figure 7

- E. If possible, lean guide rods outward, away from machine in order to provide the most room for installing weight plates.
- F. Slide top weight up and out of machine and carefully set it aside.
- G. Wipe guide rods clean over entire length. Lubricate with light coating of medium weight automotive engine oil.

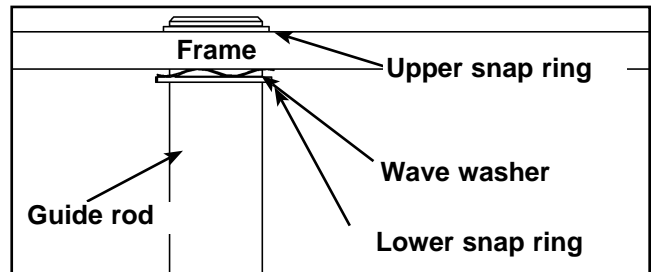

Figure 8

- H. Carefully install each weight plate one at a time. **NOTE:** When installing weight plates, position plates so wide edges of bushing face upward and narrow edges of bushing face downward. See Figures 9A and 9B.

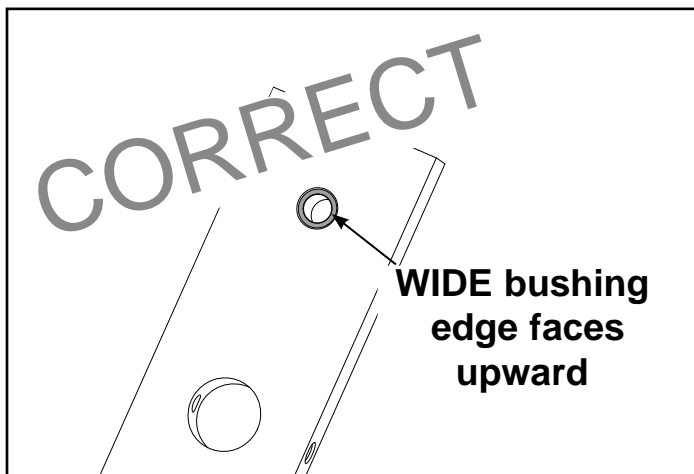

Figure 9A

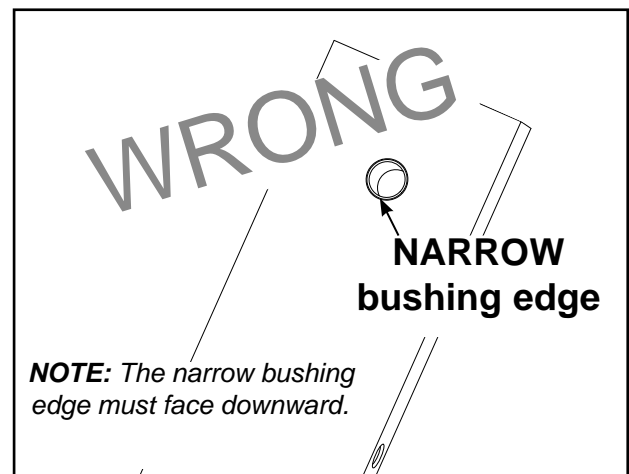

Figure 9B

- I. Slide top weight onto guide rods.
- J. Place lower snap ring and wave washer onto guide rod (about 3" from the top end of guide rod).
- K. Raise guide rod up through mounting hole and install the upper snap ring.
- L. Lower guide rod and secure lower snap ring. Repeat steps 6J - 6L for the other guide rod.

7. Belt Routing.

- A. Verify belt is routed through top of pulley bracket and then route end of belt down to the top weight.
- B. Carefully lift top weight and verify that the position of the belt clamp (on the top weight) is aligned properly with the top pulley bracket (on the machine). See Figure 10.
- C. Slide belt through slot in belt clamp.
- D. Verify belt and insert are installed properly, as shown in Figure 11A. **NOTE:** Do not install the insert backwards as shown in Figure 11B.
- E. Pull belt tight and secure belt to clamp with the two set screws. **NOTE:** Torque set screws 300-350 in./lbs. See Figure 12.
- F. Place weight stack pin in each plate to verify proper installation.
- G. Without selecting any resistance, lift top weight up and down (simulating normal operation).
- H. Have an assistant verify that the belt is moving smoothly and is routed straight from the top pulley bracket to the to weight belt clamp.
- I. Reinstall the six increment weights that were removed in step 6B. See Figure 13.
- J. Turn the Increment Weight Adjusting Knob to select all 15 lbs.

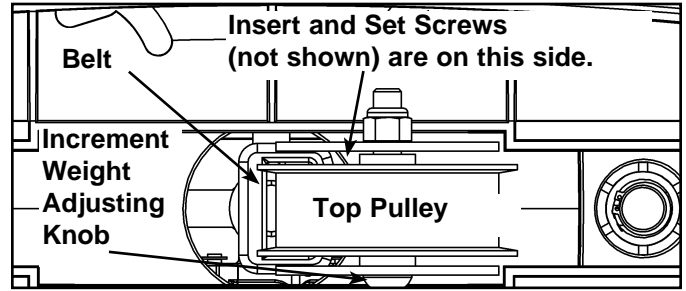

Figure 10 (top view from pulley down to belt clamp)

Correct belt routing

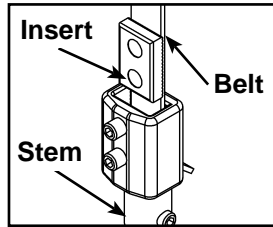

Figure 11A

Wrong belt routing

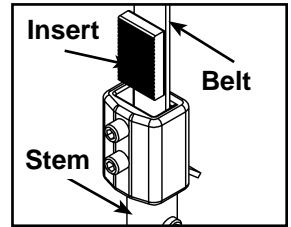

Figure 11B

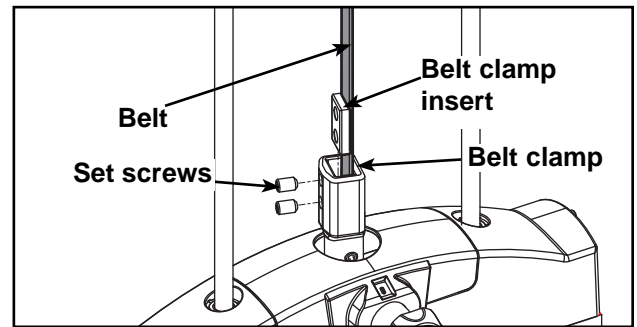

Figure 12

8. Install back shrouds.

- A. Carefully place shroud back into position on the two bottom screws. See Figure 14.

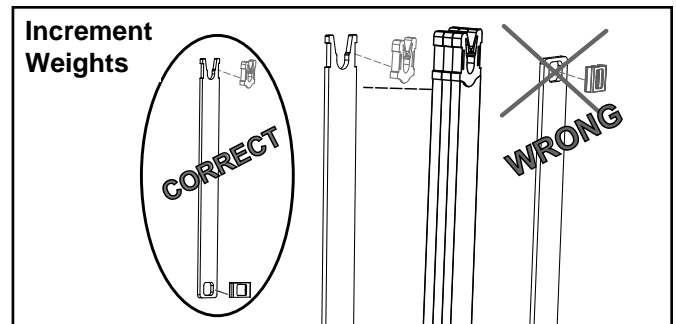

Figure 13

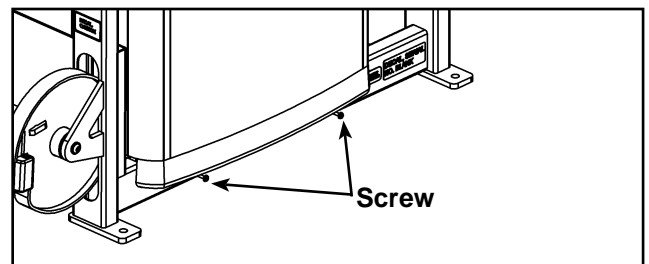

Figure 14

- B. Install the top two screws securing the back shroud. See Figure 15.
- C. Install the three Phillips head screws securing the top (back) shroud. See Figure 16.

9. Install weight plate decals.

**NOTE:** You have the option to use pounds, kilograms or both.

- A. Slowly and carefully peel off back side of decal. See Figure 17. **NOTE:** When peeling off back cover, make sure that the decals remain attached to the front sticker.
- B. Align holes in decal with appropriate holes in weight stack. **NOTE:** Do not allow the adhesive to touch weight stack at this time.
- C. Insert a guide pin through each hole of the template. **NOTE:** A guide pin can be anything that fits through the weight stack hole, such as a weight stack selector pin.
- D. Carefully align decal and rub it onto weight plates.
- E. Carefully remove front side, leaving decals adhering to weight plates. See Figure 18.

**NOTE:** It is important that you perform regular inspection and maintenance activities on your equipment. See the CYBEX Eagle Owner's Manual for inspection and maintenance activities. If you do not have a CYBEX Eagle Owner's Manual or if you have any questions or concerns, call CYBEX Customer Relations at 888-462-9239.

10. Verify proper operation

11. Anchor machine to the floor.

- A. Securely anchor machine to the floor using the anchor holes provided in each machine.

**NOTE:** Cybex is not responsible for the actual anchoring of equipment. Consult with a professional contractor.

**NOTE:** Use fasteners having a minimum of 500 lbs. tensile capacity (3/8" grade 2 bolts or better).

**NOTE:** If legs/frame does not contact surface, DO NOT pull down with anchors. Shim any leg or frame not in contact with surface using flat washers.

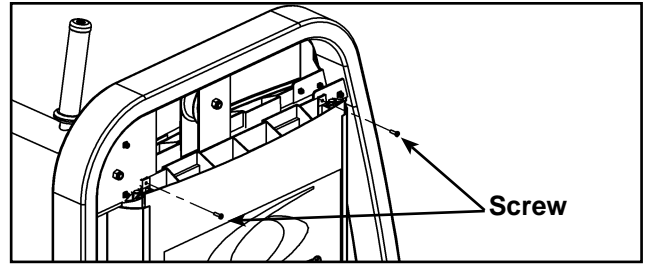

Figure 15

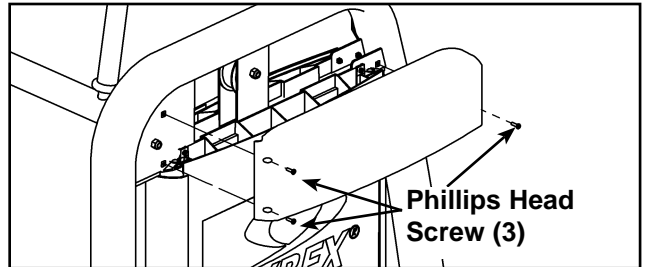

Figure 16

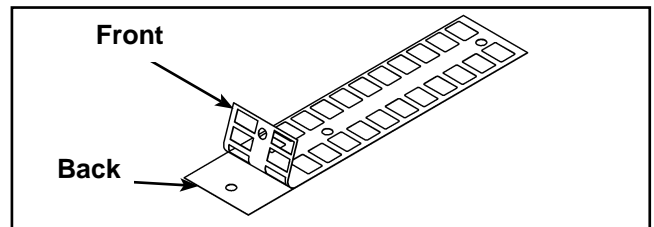

Figure 17

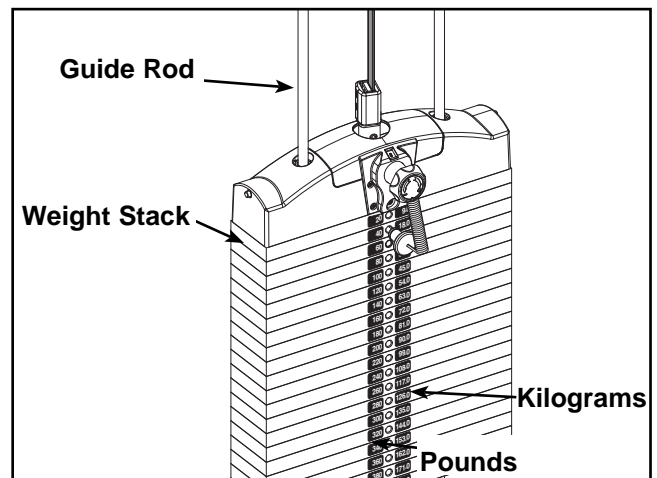

Figure 18

***This page intentionally left blank.***

## Chapter 5 - Maintenance

All preventive maintenance activities must be performed on a regular basis. Performing routine preventive maintenance actions can aid in providing safe, trouble-free operation of all Cybex Strength Systems equipment.

**NOTE:** *Cybex is not responsible for performing regular inspection and maintenance actions for your machines. Instruct all personnel in equipment inspection and maintenance actions and also in accident reporting/recording. Cybex phone representatives are available to answer any questions or concerns that you may have.*



**NOTE:** *All inspections and repairs must be performed by trained service personnel only.*

***Cybex will void warranty if non-Cybex replacement parts are used.***

### ***Daily Procedures***

1. **Upholstery** - Wipe down all upholstery as per the recommendations listed below for light soiling and more difficult stains.

#### Light Soiling

- A solution of 10% household liquid dish soap with warm water applied with a soft damp cloth.
- If necessary, a solution of liquid cleanser and water applied with a soft bristle brush. Wipe away the residue with a water dampened cloth.

### **More Difficult Stains**

- Dampen a soft white cloth with a solution of 10% household bleach (sodium hypochlorite), 90% water. Rub gently. Rinse with a water dampened cloth to remove bleach concentration.
- The same procedure can be used with full strength household bleach, if necessary.
- Allow bleach to puddle on the affected area or apply with a soaked cloth for approximately 30 minutes. Rinse with a water dampened cloth to remove any remaining bleach concentration.

### **Alternative Method for Difficult Stains**

- Dampen a soft white cloth with rubbing alcohol and rub gently. Rinse with a water dampened cloth to remove any remaining rubbing alcohol concentration.

**NOTE:** To restore luster, a light coat of spray furniture wax can be used. Apply for 30 seconds and follow with a light buffing using a clean white cloth.

### ***Please Review Carefully***

When using strong cleaning agents such as rubbing alcohol or bleach, it is advisable to first test in an inconspicuous area. Other cleaning agents may contain harsh or unknown solvents and are subject to formula changes by the product manufacturer without notice. Should you desire to use other cleaning agents, carefully try them in an inconspicuous area to determine potential damage to the material. Never use harsh solvents or cleaners which are intended for industrial applications. To clean stained or soiled areas, a soft white cloth is recommended. Avoid use of paper towels.

Cleaning products may be harmful/irritating to your skin, eyes, etc. Use protective gloves and eye protection. Do not inhale or swallow any cleaning product. Protect surrounding area/clothing from exposure. Use in a well ventilated area. Follow all product manufacturer's warnings. CYBEX and its vendors cannot be held responsible for damage or injuries resulting from the use or misuse of cleaning products.

2. Frames - Wipe down all frames using a mild solution of warm water and car wash soap. Be sure to dry thoroughly. AVOID acid or chlorine based cleaners and also cleaners containing abrasives as these could scratch or damage the equipment.
3. Chrome - Clean chrome tubes, first using chrome polish and then using a car wax seal. Neutral cleaners with a pH between 5.5 and 8.5 are recommended. Be sure to dry thoroughly. AVOID acid or chlorine based cleaners and also cleaners containing abrasives as these could scratch or damage the equipment.



**4. Guidelines for cleaning front panel:**

- Use clean soft cloths or sponges for application of cleaners and again for washing and rinsing.
- Follow up the application with warm water rinse.
- Don't use abrasives or high alkaline cleaners.
- Don't leave cleaners on for long periods, wash immediately.
- Don't apply cleaners in direct sunlight or at elevated temperatures.
- Don't use scrapers, squeegees or razors.
- Don't clean with gasoline.

**Compatible Cleaners and Detergents:**

- Formula 409
- Top Job
- Joy
- Palmolive
- Windex with Ammonia D

**To Minimize Fine or Hairline Scratches:**

Mild automotive polish applied and removed with a soft, clean cloth will help fill scratches.

**Suggested Polishes:**

- Johnson Paste Wax
- Mirror Glaze #10 Plastic Polish (by Mirror Bright Polish Co.)
- Novus Plastics Polish #1, #2 (by Novus Inc.)

**Weekly Procedures**

1. Check all nuts and bolts for looseness. Tighten as required.
2. Inspect all belts (entire length) for any **non-uniformity and wear**.

Immediately replace belt if any of the following conditions are present:

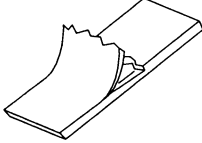
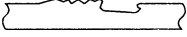
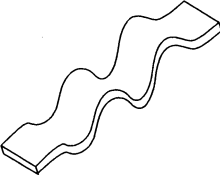
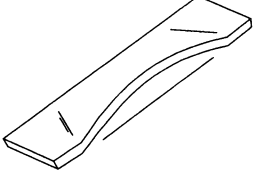
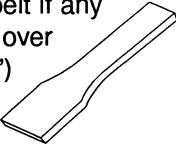
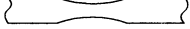
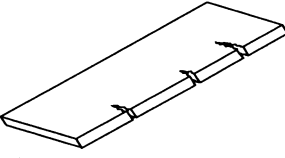
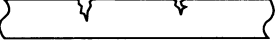
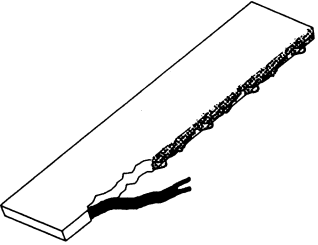
	3D View	3D or Side View
<ul style="list-style-type: none"> <li>• <b>Peeling of the belt's skin.</b></li> </ul>		
<ul style="list-style-type: none"> <li>• <b>Wave in the belt.</b></li> </ul>		
<ul style="list-style-type: none"> <li>• <b>Belt is necked down (narrow section).</b></li> </ul>	<p>Replace belt if any section is over 1/32" (.03") narrower than rest of the belt.</p> 	 <p>Examine edge of belt (both sides). Replace belt if any section is narrower than the rest.</p>
<ul style="list-style-type: none"> <li>• <b>Cracks or splits.</b></li> </ul>		
<ul style="list-style-type: none"> <li>• <b>One or more strands of kevlar hanging out.</b> <i>NOTE: Also replace belt if there is a significant amount of frayed kevlar.</i></li> </ul>		

3. Some machines use cables in addition to belts. Inspect all cables for wear or damage and proper tension. When inspecting cables, run your fingers on the cable, paying particular attention to bends in the cable and attachment points.

**Replace all worn cables immediately. The following conditions may indicate a worn cable:**

- A tear or crack in the cable sheath that exposes the cable. See Figure 1.

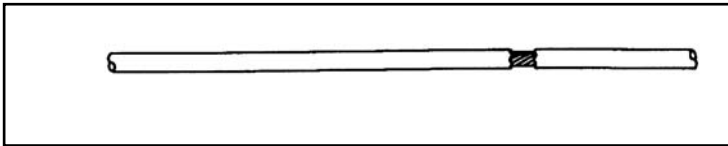

Figure 1

- A kink in the cable. See Figure 2.

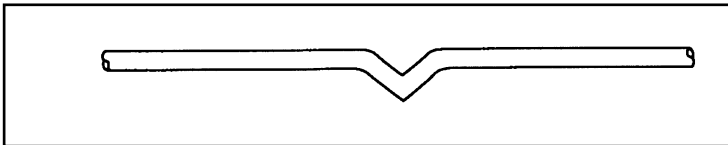

Figure 2

- A curled sheath. See Figure 3.

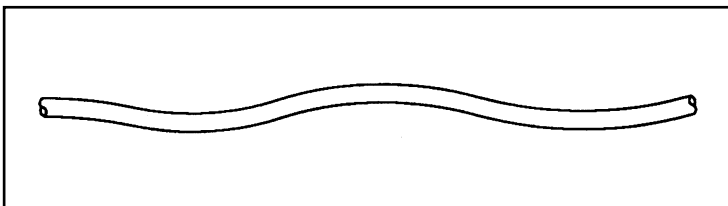

Figure 3

- "Necking", a stretched cable sheath. See Figure 4.

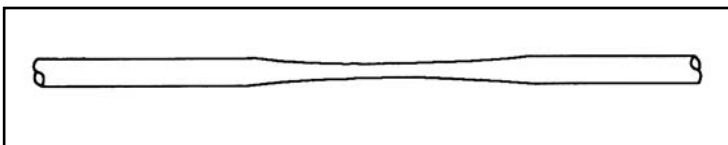

Figure 4

## ***Cybex Eagle 11090 Abdominal Owner's Manual***

4. Inspect bars and handles for wear, paying particular attention to tab area connecting points.

**Replace all worn handles immediately.**

5. Inspect snap links for proper latching (indicates wear).

**Replace all worn snap links immediately.**

6. Inspect for loose or worn grips.

**Replace all loose or worn grips immediately.**

7. Inspect all labeling for readability. This includes instructional placards, warning and caution decals.

**Replace all worn labeling immediately.**

8. Inspect all weight stacks for proper alignment and operation.

**Correct all improper alignment and operation issues immediately.**

9. Wipe Weight Stack Guide Rods clean over entire length. Lubricate with a light coat of medium weight automotive engine oil.

### ***Yearly Procedures***

1. **Replace all belts and cables at least annually.**

## **Environment**

**Static Electricity** - Depending upon where you live, you may experience dry air, causing a common experience of static electricity. This may be especially true in the winter time. You may notice a static build-up just by walking across a carpet and then touching a metal object. The same can hold true while working out on your unit. You may experience a shock due to the build-up of static electricity on your body and the discharge path of the unit. If you experience this type of situation, you may want to increase the humidity to a comfortable level through the use of a humidifier.

**Humidity** - The unit is designed to function normally in an environment with a relative humidity range of 30% to 75%.

**NOTE:** Do not install or use the unit in an area of high humidity, such as in the vicinity of a steam room, sauna, indoor pool or outdoors. Exposure to extensive water vapor, chlorine and/or bromine could adversely affect the electronics as well as other parts of the machine.

**Temperature** - The unit is designed to function normally in an environment with an ambient temperature range of 50°F (10°C) to 104°F (40°C) degrees.

## **Storage**

**Humidity** - The unit can be shipped and stored in an environment with a relative humidity range of 10% to 90%.

**NOTE:** Do not store the unit in an area of high humidity, such as in the vicinity of a steam room, sauna, indoor pool or outdoors. Exposure to extensive water vapor, chlorine and/or bromine could adversely affect the electronics as well as other parts of the machine.

**Temperature** - The unit can be shipped and stored in an environment with an ambient temperature range of 32°F (0°C) and 140°F (60°C) degrees.







10 Trotter Drive Medway, MA 02053 • 508-533-4300 • FAX 508-533-5183  
www.cybexinternational.com • techhelp@cybexintl.com